

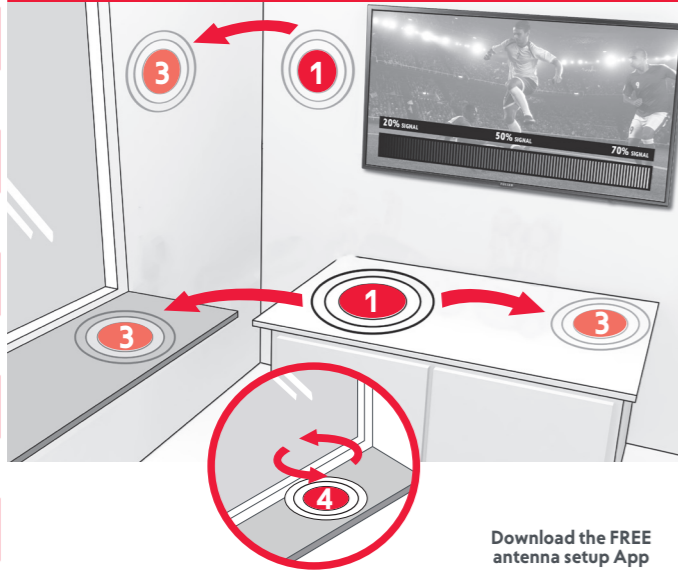

## For the best reception



- 1 Point your antenna in the direction of the nearest transmitter for best reception and most channels possible.
- 2 For closest transmitter, check: [www.ofa.com/antenna](http://www.ofa.com/antenna)
- 3 For better signal strength and/or quality, try a different location, for example near a window
- 4 For better signal strength and/or quality, turn the antenna slightly
- 5 Learn how to set up your TV antenna movie: [www.oneforall.com/support/antennas](http://www.oneforall.com/support/antennas)

Download the FREE antenna setup App



[www.oneforall.com/assistantapp](http://www.oneforall.com/assistantapp)



- DE**
- 1 Richten Sie Ihre Antenne in Richtung des nächstgelegenen Senders, um den besten Empfang und die meisten Kanäle zu empfangen
  - 2 Den nahegelegensten Sender finden Sie unter: [www.ofa.com/antenna](http://www.ofa.com/antenna)
  - 3 Um eine bessere Signalstärke und / oder -qualität zu erhalten, positionieren Sie die Antenne an verschiedenen Stellen, zum Beispiel in Fensternähe
  - 4 Für eine bessere Signalstärke und / oder -qualität, können Sie die Antenne auch in verschiedene Richtungen drehen
  - 5 Ein Video zum Aufstellen Ihrer Antenne finden Sie unter: [www.oneforall.com/support/antennas](http://www.oneforall.com/support/antennas)
- FR**
- 1 Pointez votre antenne en direction de l'émetteur le plus proche pour avoir une meilleure réception et recevoir la plupart des chaînes possibles
  - 2 Pour savoir la localisation de l'émetteur le plus proche, merci de vérifier le lien suivant: [www.ofa.com/antenna](http://www.ofa.com/antenna)
  - 3 Pour renforcer le signal et / ou avoir une meilleur qualité du signal, essayez un emplacement différent, par exemple près d'une fenêtre
  - 4 Pour renforcer le signal et / ou avoir une meilleur qualité du signal, vous devrez peut-être tourner légèrement l'antenne
  - 5 Apprenez comment configurer votre antenne TV via la vidéo dans le lien suivant: [www.oneforall.com/support/antennas](http://www.oneforall.com/support/antennas)
- ES**
- 1 Dirija su antena en dirección del transmisor mas cercano para la mejor recepción y así captar la mayor parte de canales posibles
  - 2 Para verificar donde esta el transmisor mas cercano por favor vea: [www.ofa.com/antenna](http://www.ofa.com/antenna)
  - 3 Para mejorar la intensidad de la señal y/o calidad, pruebe en una ubicación diferente, por ejemplo cerca de una ventana.
  - 4 Para mejorar la intensidad de la seña y/o calidad, es posible que tenga que girar la antena ligeramente.
  - 5 Aprenda a configurar su antena TV movie: [www.oneforall.com/support/antennas](http://www.oneforall.com/support/antennas)
- IT**
- 1 Puntare l'antenna nella direzione del trasmettitore piu' vicino per una migliore ricezione e piu' canali possibili.
  - 2 Per i trasmettitori vicini si prega di controllare: [www.ofa.com/antenna](http://www.ofa.com/antenna)
  - 3 Per una migliore potenza di segnale e/o qualita' si provi un luogo differente, per esempio vicino ad una finestra.
  - 4 Per una migliore potenza di segnale e/o qualita' potrebbe essere necessario ruotare leggermente l'antenna.
  - 5 Filmato Scopri Come Impostare La Tua Antenna TV: [www.oneforall.com/support/antennas](http://www.oneforall.com/support/antennas)

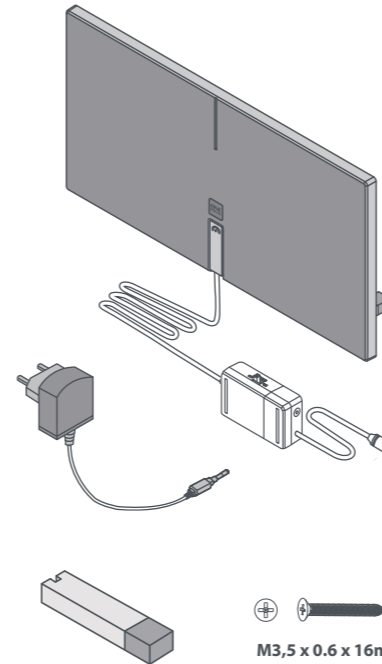

M3,5 x 0.6 x 16mm (x2) 7 x 30mm (x2)

**Power adapter UK**  
Model: H51200100B  
Input voltage: 100-240 V  
Input AC frequency: 50/60 Hz  
Output voltage: 12.0 VDC  
Output current: 0.1 A  
Average active efficiency: 74.6 %  
No-load power consumption: 0.07 W

Class II equipment. Adapter enclosure is double insulated. Risk of electric shock, do NOT open!

**Power adapter EU**  
Model: H51200100V  
Input voltage: 100-240 V  
Input AC frequency: 50/60 Hz  
Output voltage: 12.0 VDC  
Output current: 0.1 A  
Average active efficiency: 74.6 %  
No-load power consumption: 0.07 W

Class II equipment. Adapter enclosure is double insulated. Risk of electric shock, do NOT open!

**GB:** To completely remove power from the antenna, disconnect the power adaptor from the power socket.  
**Warning:** Antenna Max Height 2m.

**DE:** Um die Antenne vollständig von der Stromversorgung zu trennen, entfernen Sie das Netzteil aus der Steckdose.  
**Warnung:** Antenne Max Höhe 2m.

**FR:** Pour couper complètement l'alimentation de votre antenne, veuillez débrancher le câble alimenté secteur de la prise d'alimentation.  
**Attention:** Antenne Hauteur max 2m.

**IT:** Per rimuovere completamente l'alimentazione dall'antenna, scollegare l'alimentatore dalla presa di corrente.  
**Avvertenza:** Antenna Altezza massima 2 m.

**ES:** Para extraer completamente la alimentación de la antena, desconecte el cable de alimentación de la toma de corriente.  
**Advertencia:** Antena Altura máxima 2m.

## 1 START

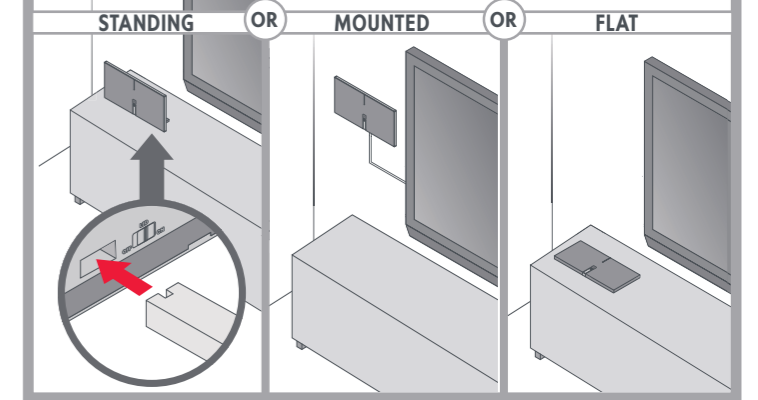

## 2

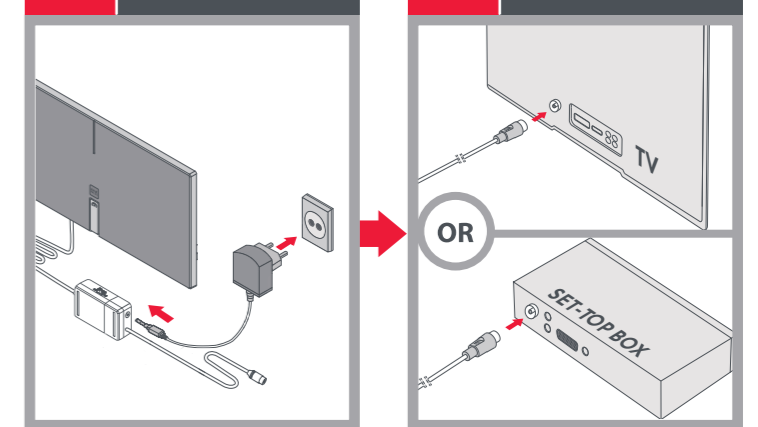

## 3

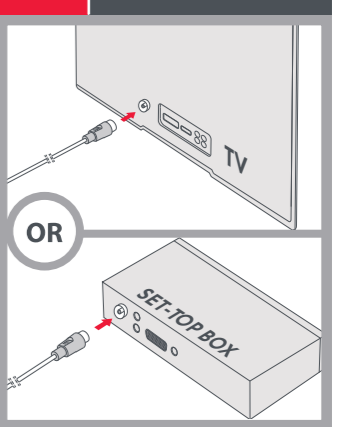

## 4 POSITION THE ANTENNA:

LED ON-OFF

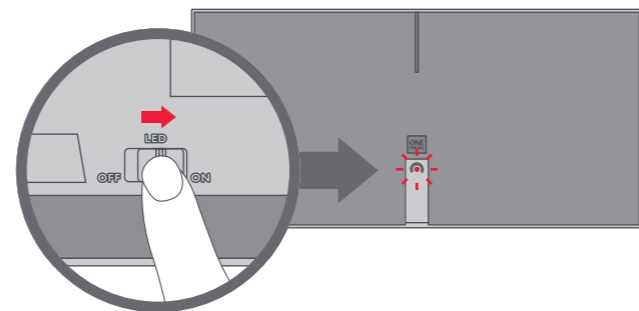

POWER ON-OFF

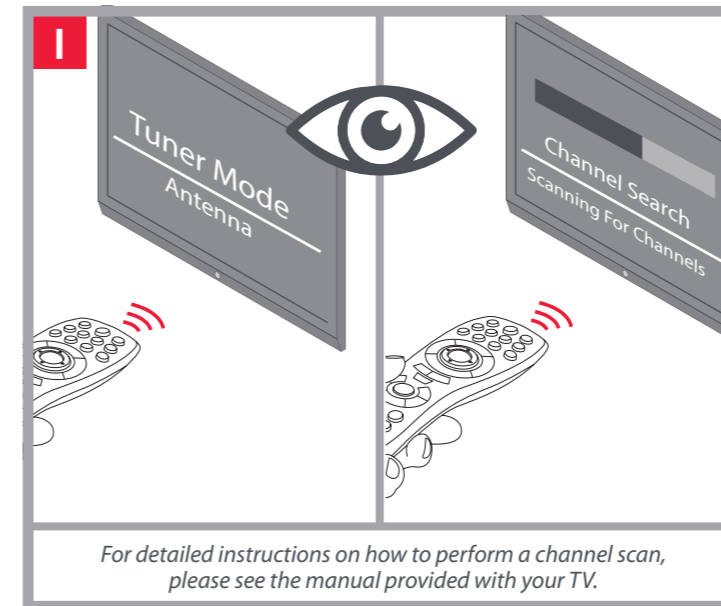
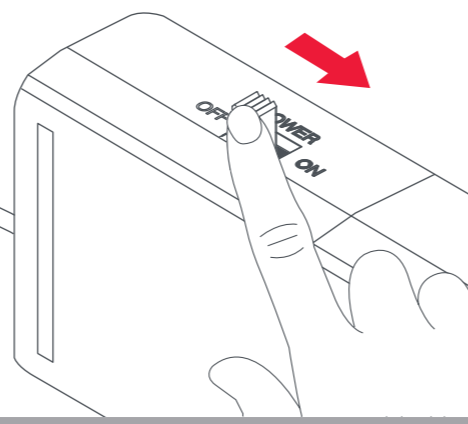

For detailed instructions on how to perform a channel scan, please see the manual provided with your TV.

# FINISH

[WWW.ONEFORALL.COM/TIPS-AND-TRICKS](http://WWW.ONEFORALL.COM/TIPS-AND-TRICKS)

Connect with us



facebook.com/oneforallworldwide



@oneforall.worldwide



linkedin.com/company/one-for-all-worldwide/



youtube.com/users/oneforallproducts

TURN THE ANTENNA SLIGHTLY FOR BETTER SIGNAL STRENGTH OR RECEPTION QUALITY - [www.oneforall.com/support/antennas](http://www.oneforall.com/support/antennas)

